



IXrouter3

Installation Manual

Table of contents

| | |
|--|-----------|
| 1. Introduction | 2 |
| 1.1 Technical support | 2 |
| 2 Product overview | 3 |
| 2.1 Product family | 3 |
| 2.2 What's in the box? | 3 |
| 2.3 Hardware overview | 4 |
| 2.4 Specifications | 6 |
| 2.5 Dimensions | 8 |
| 3. Installation | 9 |
| 3.1 Considerations | 9 |
| 3.2 Installing and removing from DIN rail | 10 |
| 3.3 Installing a SIM card | 10 |
| 3.4 Power supply | 11 |
| 3.5 Wiring | 11 |
| 4. Operation | 13 |
| 4.1 Configure the IXrouter3 | 13 |
| 4.2 The IXrouter3 local web interface | 13 |
| 4.3 LED status indicators | 14 |
| 4.4 Reset to factory default | 15 |
| 5. Connectivity requirements (for local IT) | 16 |
| 5.1 Overview | 16 |
| 5.2 Servers and DNS requests | 16 |
| 5.3 MAC or IP address filter | 17 |
| 6. Compliance | 18 |
| 6.1 Certifications | 18 |
| 6.2 Applicable European directives | 18 |
| 6.3 Applicable safety standards | 18 |
| 6.4 FCC compliance | 20 |
| 6.5 ANATEL | 21 |
| 6.6 NBTC | 21 |

1. Introduction

Thank you for purchasing the IXrouter3. The IXrouter is the standard and most supported hardware for IXON's IXON Cloud. The IXrouter makes it convenient to remotely connect to your equipment, while the built-in firewall keeps your equipment safe from outside threats.

Configuration is as easy as inserting a USB flash drive, which contains your configuration file, into the IXrouter's USB port. The configuration file can be generated from the [Tools] page in the IXON Cloud Fleet Manager app.

1.1 Technical support

If for any reason you need technical assistance, please have a look at our easy-to-read and exhaustive online support articles and guides (support.ixon.cloud), send us an e-mail (support@ixon.cloud), or give us a call at +31 85 744 11 05. Our technical support is available from 8:00 to 17:00 Central European Time, on working days and will answer your questions as soon as possible.

If you have a comment, question, or suggestion about any of our products, services, or manuals, don't hesitate to let us know.

2 Product overview

Seamlessly integrated with the IXON Cloud, the IXrouter is the fastest and safest way to connect your machine to the cloud.

2.1 Product family

The IXrouter3 is available in several variations. No matter your situation, you can always connect your machine to the cloud.

| Article no. | Ethernet | 4G/LTE | Wi-Fi |
|---------------|----------|--------|-------|
| IX2400 | ✓ | | |
| IX2405 | ✓ | ✓ | |
| IX2410 | ✓ | | ✓ |
| IX2415 | ✓ | ✓ | ✓ |

Antenna and SIM card

All models that support 4G and/or WiFi require antennas, which can be purchased separately. SIM Cards for the models that support 4G can be purchased through a telecom provider in your region.

2.2 What's in the box?

The following list describes the contents of the package:

- IXON IXrouter3
- 4GB USB flash drive for configuration
- Female 4-pin plug-in connector with screw connection
(model Weidmuller BL 5.08/04/180 SN BK BX or equivalent)
- Quick Start Guide

2.3 Hardware overview

The IXrouter3 is created with performance and a multitude of hardware capabilities in mind. Figure one, depicted below gives an overview of the hardware functionalities of the IXrouter3.

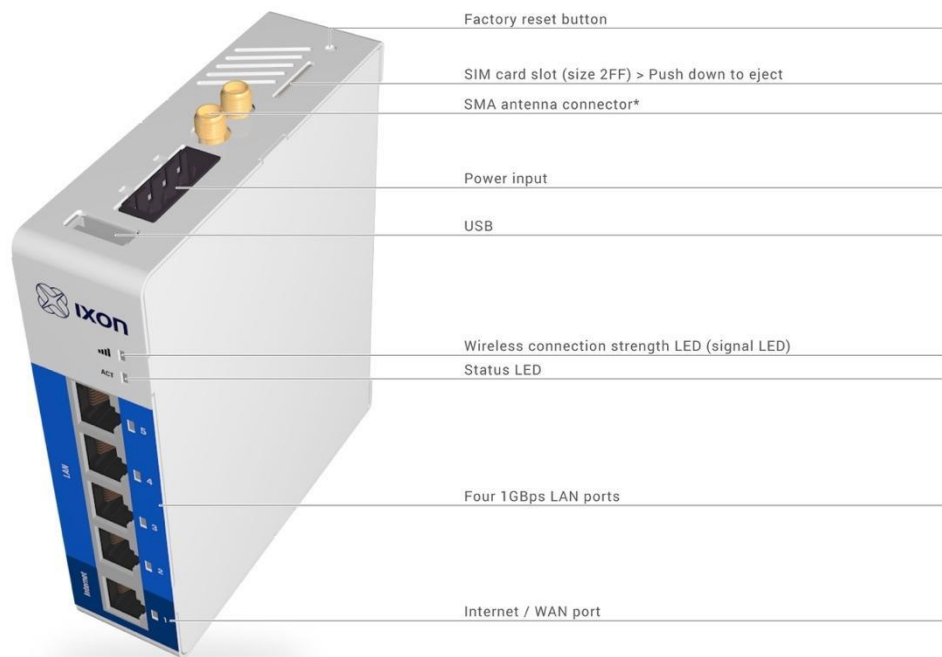

The amount of SMA connectors depends on the model. They are structured according to the following order:

- 4G: The MAIN connector is closest to the power connector, the other connector is DIV. Always connect one antenna to the MAIN connector, the DIV connector is optional.
- 4G & Wi-Fi: The 4G connector is closest to the power connector, the other connector is the Wi-Fi connector.
- Wi-Fi: Only one connector.
- Ethernet: No antenna connectors

Figure SEQ Figure * ARABIC 1:
Hardware overview



Vierlingsbeekseweg 52A
5825 AX Overloon, NETHERLANDS
Made in The Netherlands

MAC: CO:D3:91:31:BB:CB
WIFI MAC: D4:CA:9E:90:EA:05
IMEI 313513513516435
Input: DC 12-24 V +/- 20%
PW: aBC123def4
FCC ID: XPYLILYW1 IC: 8595A-LILYW1
FCC ID2: XMR201903EG25G IC2: 10224A-201903EG25G

IXrouter 3.0 4G WiFi

IX2415

S/N: 12345678



2052

Figure 2: IXrouter3 label (can be found on the left side of the router)

The label depicted in figure 2 shows some very important information on your specific IXrouter3. On the right side of the label you can find information on certifications, the model and the serial number (s/n). A QR-code with the routers serial number is also provided on the label. On the left side you can find IXON's contact information and the MAC and IMEI numbers, which are unique to your router. A password (PW) to access the local web interface is also on the left side of the label.

2.4 Specifications

The specifications below are applicable for all IXrouter3 models. The 4G/LTE and Wi-Fi models each have additional specifications, listed separately.

| General specifications | Description |
|-----------------------------------|--|
| Power supply (recommended) | 12-24 VDC +/- 20% LPS 2A |
| Power consumption | IX2400: 2.5W idle, 10W max Other models: 5W idle, 10W max |
| Operating temperature | -20°C to 65°C |
| Relative humidity | 10 to 95% non-condensing |
| Operating altitude | Up to a maximum of 2000m |
| Storage temperature | -20°C to 65°C |
| Storage humidity | 10 to 95% non-condensing |
| Storage altitude | Up to a maximum of 3000m |
| Ethernet ports | 4 LAN ports, 1 WAN port. (all 1 Gbps) |
| USB version | USB 2.0 |
| Processor | MIPS 800 MHz |
| Digital Input | Yes |
| Degree of protection | IP20 |
| Mounting | DIN rail |
| Size | 95x116x28mm (excl. DIN rail) |
| Weight | 270-310 gram |
| Certifications | CE, cULus Listing, FCC Verification, NBTC |
| Warranty | 2 Years |

| Cellular specifications | Description |
|---|---|
| Cellular protocols and frequencies | FDD-LTE - B1, B2, B3, B4, B5, B7, B8, B12, B13, B18, B19, B20, B25, B26, B28 TDD-LTE - B38, B39, B40, B41 WCDMA - B1, B2, B4, B5, B6, B8, B19 GSM/GPRS/EDGE - 850, 900, 1800, 1900 MHz |

| | |
|---|---|
| Speed (Max. download/upload) | LTE-FDD - Max 150Mbps (DL)/Max 50Mbps (UL) LTE-TDD - Max 130Mbps (DL)/Max 30Mbps (UL) DC-HSDPA - Max 42Mbps (DL) HSUPA - Max 5.76Mbps (UL) WCDMA - Max 384Kbps (DL)/Max 384Kbps (UL) EDGE - Max 296Kbps (DL)/Max 236.8Kbps (UL) GPRS - Max 107Kbps (DL)/Max 85.6Kbps (UL) |
| SIM size | 2FF (Standard SIM Card) |
| FCC ID | XMR201903EG25G |

| Wi-Fi specifications | Description |
|----------------------------------|--|
| Wi-Fi IEEE 802.11 version | b/g/n |
| Security protocols | WPA2-PSK |
| Radio Frequency | 2.4 GHz |
| Wi-Fi modes | Station (Client) Mode and Access Point |
| Speed | 72Mbps |
| FCC ID | XPYLILYW1 |

2.5 Dimensions

The IXrouter3 is designed to be easily installed on a standard DIN rail. The small size of the IXrouter3 allows you to make efficient use of space. (Unit of measurement: millimeter.)

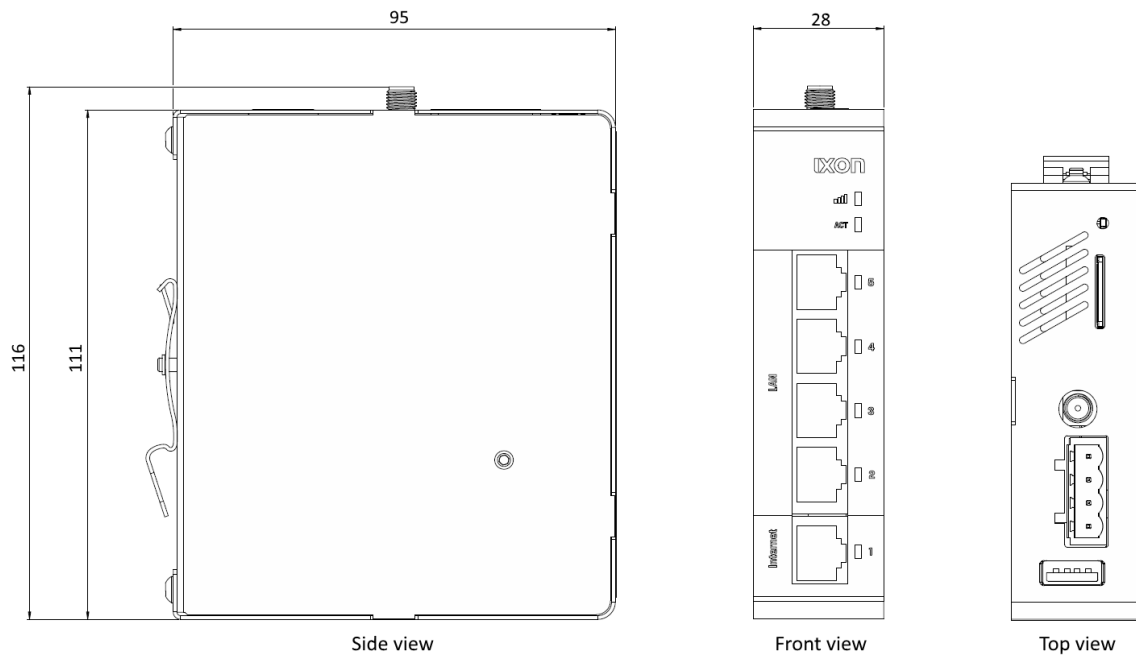

Figure 3: IXrouter3 dimensions

3. Installation

3.1 Considerations

When designing the layout of your system, always separate the devices that generate high voltage and high electrical noise from the low-voltage, logic-type devices such as the IXrouter3.

Also consider the heat-generating devices and locate the electronic-type devices in the cooler areas of your cabinet. Reducing the exposure to a high-temperature environment will extend the operating life of the IXrouter3.

Also consider the routing of the wiring for the devices in the panel. Avoid placing low-voltage signal wires and communications cables in the same tray with AC power wiring and high-energy, rapidly-switched DC wiring.

The IXrouter3 is designed to be cooled using natural convection. For proper cooling, you must provide a clearance of at least 25 mm above and below the device. Also, allow at least 25 mm of depth between the front of the device and the inside of the enclosure.

These devices are open-type and are meant to be installed in an enclosure which is only accessible with the use of a tool. These devices are meant to be suitable for the environment.

Because IXON's IXrouter3 is essentially a small computer, the IXrouter3 can be used for many different purposes. You can, for example, access, program and control industrial machines around the globe. Do not use the IXrouter3 unless you've received proper training or have proper knowledge about the IXrouter3 and its capabilities. It is expected that the user is knowledgeable about networking settings and is aware of the potential consequences for your application.

Beware

It is prohibited to open the case of the IXrouter. Doing so is considered "improper use" and will void the warranty.

3.2 Installing and removing from DIN rail

The IXrouter3 can be easily installed on a standard DIN rail. (1) Hang the device on the rail and (2) push the unit down until you feel a click. To remove the unit, (A) pull/rotate the device up and (B) lift off the rail.

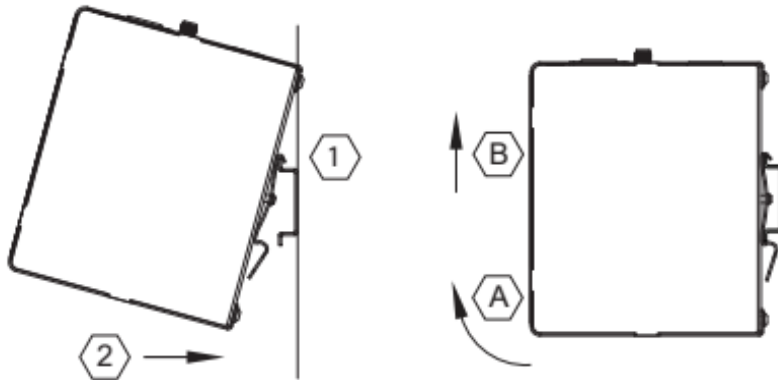

Figure 4: DIN-rail installation

3.3 Installing a SIM card

The SIM card slot suits a Full-Size SIM card (size 2FF).

To insert, push the SIM card into the slot until you feel a click.

This is approximately when the card is fully submerged 1 mm inside the device. Release the card and the card will stay in the device.

The side of the SIM card where you see a golden colored chip should be aligned with the outside of the enclosure as depicted on the router and in the figure on the right.

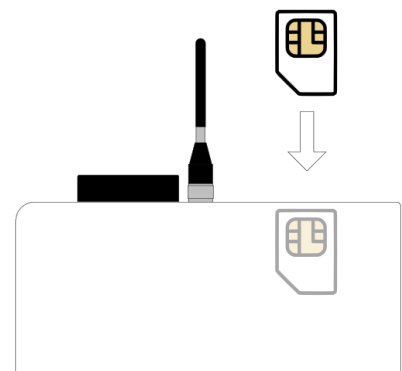

To remove, push the SIM card firmly into the slot until you hear a click. Releasing will cause the SIM card to partially eject, allowing you to easily take out the card.

3.4 Power supply

The IXrouter3 must be powered by an IEC/UL/EN/60950-1 certified Limited Power Supply (LPS) or, for the United States, a Class 2 power supply. The LPS power supply is not included in the package of the IXrouter 3.

| | |
|------------------------------------|--------------------------------------|
| Power supply | 12-24 VDC +/- 20% LPS 2A |
| Internal voltage protection | 29V max |
| Input protection | Protected against polarity inversion |
| Isolation | 1.5 kV |

3.5 Wiring

Proper grounding and wiring of all electrical equipment are important to help ensure the optimum operation of the IXrouter3 and to provide additional electrical noise protection for your application.

The IXrouter3 comes with a female 4-pin plug-in connector with screw connection (type: Weidmuller BL 5.08/04/180 SN BK BX). The optimal wire diameter is 1.5mm² (16AWG - 12AWG).

Connect the Shield pin of the IXrouter with the protective earth conductor (PE), min. core diameter Cu 1.5 mm².

| | |
|------------------------------|----------------|
| Wire size range | 18 - 12 AWG |
| Wire strip length | 7 mm |
| Terminal screw torque | 0.4 Nm |
| Max wire length | 3m |
| Min ground conductor | 16 AWG |

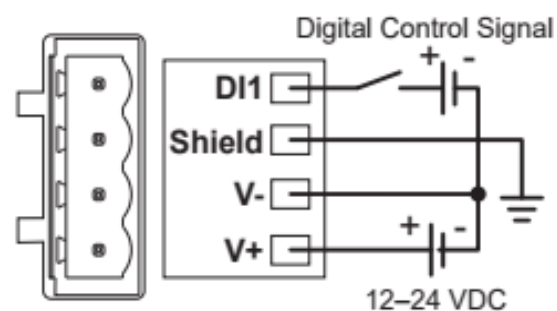

Beware

You have to use the 4-pin plug-in connector included in the IXrouter3 packaging when wiring the IXrouter3. Failing to do so is considered "improper use", meaning that any damages as a direct result of this are not covered by warranty.

By default, the Digital Input is not configured and doesn't need to be wired. The digital input provides a way to locally manage IXrouter3's VPN connection (ON/OFF). The wiring is depicted in the image above.

| | |
|-----------------------------------|-------------|
| Type | optocoupler |
| Voltage range | 0-29 VDC |
| Voltage range (OFF state) | 0-3 VDC |
| Voltage range (ON state) | 7-29 VDC |
| Current voltage (On state) | 2-5 mA |

More info

For configuration instructions, please take a look at our [online article](#).

4. Operation

4.1 Configure the IXrouter3

To configure your IXrouter3, log in to your IXON Cloud account and navigate to the [Tools] page. Here you can generate an IXrouter configuration file by following a few simple steps. You can then download the configuration file, which must be copied onto a USB flash drive. After supplying power to the IXrouter, insert this USB flash drive in the USB port. The IXrouter3 will register itself to IXON's IXON Cloud and set up a secure VPN connection. You can further configure the IXrouter via the IXON Cloud (portal.ixon.cloud).

More info

For a more extensive manual we recommend viewing our [online step-by-step guides](#).

4.2 The IXrouter3 local web interface

You can use the IXrouter3's local web interface to register the router if it's not registered in the IXON Cloud, change the WAN, LAN and Firewall configurations locally or use the status overview as a more advanced alternative to the LED statuses. You can open the local web interface by connecting your router to your computer using one of the router's LAN ports and entering <http://IXrouter3.lan> in your browser. You have to enter the password on the side of your router to make changes in the local web interface.

More info

For a more extensive explanation on how to use the local web interface, please take a look at our [online article](#).

4.3 LED status indicators

The IXrouter has two LEDs located right above the LAN ports. These show the current status of the IXrouter's connection. The upper LED indicator () displays the signal status, only applicable for 4G/LTE and Wi-Fi models, and the lower LED indicator (**ACT**) shows the activity status. The table below provides an overview of all possible LED status indications.

| Signal LED | | |
|---|----------------------------|---|
|  | Blinking blue | Initializing cellular module |
|  | Blinking blue 1 pulse | No reception or unable to connect to network (APN or SSID may be incorrect) |
|  | Blinking red 1 pulse | No reception or unable to connect to network (APN or SSID may be incorrect) |
|  | Blinking red 2 pulses | Firmware 3.22: PIN invalid Firmware 3.21.1 and lower: PIN invalid or PUK required |
|  | Blinking red 3 pulses | PUK required (a phone is required to unlock SIM card with PUK) |
|  | Blinking red 4 pulses | SIM card is invalid or missing |
|  | Constant red | Connected, poor reception |
|  | Constant purple | Connected, medium reception |
|  | Constant blue | Connected, good reception |
| ACT Activity LED | | |
|  | Constant red | Booting up (may take 1-2 min) or not yet registered |
|  | Blinking red 1 pulse | Waiting for internet access |
|  | Blinking red 3 pulses | LAN/WAN conflict (conflicting subnets) |
|  | Blinking red 4 pulses | Removed from the platform (re-insert USB flash drive to register again) |
|  | Blinking red 5 pulses | Previously registered to the IXON Cloud (remove from the IXON Cloud and register again) |
|  | Blinking blue 1 pulse | Connecting to the IXON Cloud |
|  | Blinking blue 1 long pulse | VPN is manually disabled |
|  | Blinking blue 2 pulse | Setting up a VPN connection |
|  | Constant blue | Active VPN connection to the IXON Cloud |

More info

For a list of most common causes and troubleshooting tips, view our [online troubleshooting article](#).

4.4 Reset to factory default

After doing a factory reset you'll have to register the device again. If the device is still listed in the IXON Cloud and you want to re-use those settings, make sure to turn on **Recovery mode** before registering again. The IXrouter3 itself can be reset to the factory default settings by pressing and holding the reset button on top for 5 seconds. The ACT LED will start blinking shortly after the reset button is pressed. Keep holding the button until the LEDs stop flashing and then let go. Wait for the IXrouter3 to restart, this can take up to 2 minutes. You can now reconfigure the IXrouter3 if desired.

Warning!

This cannot be undone. All settings will be reset to factory default.

5. Connectivity requirements (for local IT)

The IXrouter uses outgoing ports to establish a secure connection to our IXON Cloud. This means there is no need to open any incoming ports in your firewall.

5.1 Overview

Below is an overview of the outgoing ports and protocols that the IXrouter utilizes.

| Direction | Port | Transport | Application |
|-----------|--------------------------|---------------------|--|
| Outbound | 443 | TCP | HTTPS, MQTT (TLS) OpenVPN ⁽¹⁾ |
| Outbound | 1194 ⁽²⁾ | UDP | OpenVPN |
| Outbound | 8443 ⁽³⁾ | TCP | HTTPS |
| Outbound | 53 ⁽⁴⁾ | TCP & UDP | DNS |
| Outbound | (no port) ⁽⁵⁾ | ICMP (Echo request) | - |

(1) The very first package may be considered unencrypted as the OpenVPN handshake takes place prior to the TLS handshake. For this reason an exception may be required on firewall rules that block non-SSL traffic over SSL-ports.

(2) Only used when VPN connection type is set to UDP.

(3) Only used when stealth mode is activated for connectivity via a censored internet connection (i.e. when located in China).

(4) DNS requests are often handled by local DNS servers. In those cases the listed DNS port can be ignored.

(5) Only used when failover is configured.

5.2 Servers and DNS requests

The IXrouter connects to different IXON servers: REST API, MQTT, and OpenVPN servers, which include the following domains: .ixon.cloud; .ixon.net; .ayayot.com (phonetic IIoT).

Doing a DNS lookup (nslookup) at the following domain name always returns an up-to-date IP list of all current IXON servers: whitelist.ixon.cloud

5.3 MAC or IP address filter

Internet access may be granted to specific devices, based on their MAC or IP addresses. The IXrouter's MAC address can be obtained from the label on the side of the IXrouter. The IP address can be set to a static IP address. However, by default the IP address is set to be assigned dynamically via DHCP.

More info

More detailed information on connectivity requirements is available on our support website.

- How to use [stealth mode](#)
- A guide to [set up a static IP](#)

6. Compliance

6.1 Certifications

The IXrouter3 has been certified for:

- **CE** certification (for more information, see our [Declaration of Conformity](#)).
- **FCC** verification
- **cULus** listing (ID #E492721)
- **ANATEL** (models IX2400 and IX2410)
- **NBTC**
- **Verizon** (4G/LTE Global only)



6.2 Applicable European directives

The IXrouter3 is in conformity with the provisions of the following European Directives.

| Directive | Description |
|--------------------------------------|--|
| EMC Directive 2014/30/EU | Product safety |
| Radio Equipment Directive 2014/53/EU | Use of the radio spectrum |
| RoHS Directive 2015/863 | Restriction of hazardous substances |
| REACH Directive 1907/2006 | Regulation and registration of chemicals |
| WEEE Directive 2012/19 | Waste of electronic equipment |

6.3 Applicable safety standards

The IXrouter3 was tested and passed the following standards.

| Standard | Description |
|-------------------------------|--|
| EN 55032:2012/AC:2013 | Electromagnetic Compatibility of Multimedia Equipment |
| EN 301 489-1 V1.9.2 (2011-09) | EMC Standard for Radio Equipment and Services, Part 1: Common technical requirements |

| | |
|--|--|
| EN 301 489-3 V1.4.1 (2002-08) | EMC Standard for Radio Equipment and Services, Part 3: Specific conditions for Short-Range devices. |
| EN 61000-6-1:2007 | Electromagnetic compatibility (EMC) - Part 6-1: Generic standards - Immunity for residential, commercial and light-industrial environments |
| EN 61000-6- 3:2007/A1:2011/AC:2012 | Electromagnetic compatibility (EMC) - Part 6-3: Generic standards - Emission standard for residential, commercial and light-industrial environments |
| EN 61000-6-2:2005/AC:2005 | Electromagnetic compatibility (EMC) - Part 6-2: Generic standards - Immunity for industrial environments |
| EN 61000-6-4:2007 + A1:2011 | Electromagnetic compatibility (EMC) - Part 6-4: Generic standards - Emission standard for industrial environments |
| EN 61000-4-2:2009 | Electrostatic discharge immunity test |
| EN 61000-4-3:2006 + A1:2008 + A2:2010 | Radiated, Radio-frequency, Electromagnetic Field Immunity Test 80-1000 MHz |
| EN 61000-4-4:2012 | Burst Immunity Test |
| EN 61000-4-5:2014 + A1:2017 | Surge Immunity Test |
| EN 61000-4-6:2014 | Immunity to Conducted Disturbances, Induced by Radio-frequency Fields |
| IEC 60950-1:2006 + A1:2009 + A2:2013 | Information Technology Equipment Safety, Part 1: General Requirements - Edition 2 |
| EN 62368-1:2014/AC:2015 | Audio/video, information and communication technology equipment - Part 1: Safety requirements |
| EN 50581:2012 | Restriction of the use of certain hazardous substances (RoHS) in electrical and electronic equipment |
| UL 60950-1 | Information Technology Equipment Safety, Part 1: General Requirements - Edition 2 |
| CSA C22.2 No. 60950-1-07 + Amendment 1 and Amendment 2 | Information Technology Equipment Safety, Part 1: General Requirements - Edition 2 |

6.4 FCC compliance

The base equipment (an unintentional radiator) has been tested and complies with the limits for a Class B digital device, pursuant to part 15 of the FCC rules. These limits are designed to provide reasonable protection against harmful interference in a residential installation. This equipment generates, uses, and can radiate radio frequency energy and, if not installed and used in accordance with the manufacturer's instruction manual, may cause interference with radio and television reception.

However, there is no guarantee that interference will not occur in a particular installation. If this equipment does cause harmful interference to radio or TV reception, which can be determined by turning the equipment off and on, the user is encouraged to try to correct the interference by one or more of the following measures:

- Reorient or relocate the receiving antenna.
- Increase the separation between the equipment and the receiver.
- Connect the equipment into an outlet on a circuit different from that to which the receiver is connected.
- Consult the dealer or an experienced radio/TV technician for help.

Notice

Changes or modifications of this equipment not expressly approved by the party responsible for compliance could void the user's authority to operate the equipment.

The IXrouter3 contains different FCC certified modules, depending on the model.

| Article no. | Enclosed module | FCC ID |
|---------------|-----------------|---------------------------|
| IX2400 | - | - |
| IX2405 | 4G/LTE | XMR201903EG25G |
| IX2410 | Wi-Fi | XPYLILYW1 |
| IX2415 | 4G/LTE & Wi-Fi | XMR201903EG25G, XPYLILYW1 |

Additional information for models with wireless capabilities

This device complies with Part 15 of the FCC Rules. Operation is subject to the following two conditions:

- This device may not cause harmful interference.
- This device must accept any interference received, including interference that may cause undesired operation.

The antenna(s) used with this transmitter must be installed with a separation distance of at least 20cm from all persons and must not be co-located or operated in conjunction with any other antennas or transmitters. Only those antenna(s) tested with the wireless transmitters or similar antenna(s) with equal or lesser gain may be used.

6.5 ANATEL

Para maiores informações, consulte o site da ANATEL www.gov.br/anatel/pt-br/.

Este equipamento não tem direito à proteção contra interferência prejudicial e não pode causar interferência em sistemas devidamente autorizados.

6.6 NBTC

เครื่องโทรคมนาคมและอุปกรณ์นี้ มีความสอดคล้องตามมาตรฐานหรือข้อกำหนดทางเทคนิคของ กสทช.

เครื่องวิทยุคมนาคมนี้ มีระดับการแผ่คลื่นแม่เหล็กไฟฟ้าสอดคล้องตามมาตรฐาน ความปลอดภัยต่อสุขภาพของมนุษย์จากการใช้เครื่องวิทยุคมนาคมที่คณะกรรมการกิจการโทรคมนาคมแห่งชาติประกาศ หนด.



เครื่องวิทยุคมนาคมนี้ ได้รับยกเว้น ไม่ต้องได้รับใบอนุญาตให้มี ใช้งานซึ่งเครื่องวิทยุคมนาคม หรือตั้งสถานีวิทยุคมนาคมตามประกาศ กสทช. เรื่อง เครื่องวิทยุคมนาคม และสถานีวิทยุคมนาคมที่ได้รับยกเว้นไม่ต้องได้รับใบอนุญาตวิทยุคมนาคม ตามพระราชบัญญัติวิทยุคมนาคม พ.ศ. 2498



nanb. | โทรคมนาคม
กำกับดูแลเพื่อประชาชน
Call Center 1200 (Insw5)

Drawings and official documents

All supporting documents can be found on our [online documents article](#).